



# 18V Li-Ion Brushless Impact Wrench 220N.m J系列锂电无刷冲击扳手 220N.m

51073C



中文 使用说明书

EN OPERATION INSTRUCTION





# 电动工具的通用安全警告：

## 警告

阅读所有警告和所有说明。不遵照以下警告和说明会导致电击、着火和/或严重伤害。保存所有警告和说明书以备查阅。在所有下列的警告中术语“电动工具”指市电驱动（有线）电动工具或电池驱动（无线）电动工具。

### 通用电动工具安全警告 - 工作场地

- 1) 保持工作场地清洁和明亮。混乱和黑暗的场地会引起事故。
- 2) 不要在易爆环境，如有易燃液体、气体或粉尘的环境下操作电动工具。电动工具产生的火花会点燃粉尘或气体。
- 3) 让儿童和旁观者离开后操作电动工具。注意力不集中会使操作者失去对工具的控制。

### 通用电动工具安全警告 - 电气安全

- 1) 电动工具插头必须与插座相配。绝不能以任何方式改装插头，需接地的电动工具不能使用任何转换插头。未经改装的插头和相配的插座将减少触电危险。
- 2) 避免人体接触接地表面，如管道、散热片和冰箱。如果你身体接地会增加电击危险。
- 3) 不得将电动工具暴露在雨中或潮湿环境中。水进入电动工具将增加电击危险。
- 4) 不得滥用电线。绝不能用电线搬运、拉动电动工具或拔出其插头。让电动工具远离热源、油、锐边或运动部件。受损或缠绕的软线会增加电击危险。
- 5) 当在户外使用电动工具时，使用适合户外使用的外接软线。适合户外使用的软线将减少电击危险。
- 6) 如果在潮湿环境下操作电动工具是不可避免的，应使用剩余电流动作保护器（RCD）。使用RCD可减小电击危险。

### 通用电动工具安全警告 - 人身安全

- 1) 保持警觉，当操作电动工具时关注从事的操作并保持清醒。当你感到疲倦，或在有药物、酒精或治疗反应时，不要操作电动工具。在操作

电动工具时瞬间的疏忽会导致严重人身伤害。

- 2) 使用个人防护装置。始终配戴护目镜。安全装置，诸如适当条件下的防尘面具，防滑安全鞋，安全帽，听力防护等装置能减少人身伤害。
- 3) 防止意外起动。确保开关在连接电源和/或电池盒、拿起或搬运工具时处于关断位置。手指放在已接通电源的开关上或开关处于接通时插入插头可能会导致危险。
- 4) 在电动工具接通之前，拿掉所有调节钥匙或扳手。遗留在电动工具旋转零件上的扳手或钥匙会导致人身伤害。
- 5) 手不要伸展得太长，时刻注意立足点和身体平衡。这样在意外情况下能很好地控制电动工具。
- 6) 着装适当。不要穿宽松衣服或佩戴饰品。让衣服、手套和头发远离运动部件。宽松衣服，佩饰或长发可能会卷入运动部件中。
- 7) 如果提供了与排屑装置，集尘设备连接用的装置，要确保他们连接完好且使用得当。使用这些装置可减少尘屑引起的危险。

### 通用电动工具安全警告 - 电动工具使用和注意事项

- 1) 不要滥用电动工具，根据用途使用适当的电动工具。选用适当设计的电动工具会使你工作更有效、更安全。
- 2) 如果开关不能接通或关断工具电源，则不能使用该电动工具。不能用开关来控制的电动工具是危险的且必须进行修理。
- 3) 在进行任何调节，更换附件或贮存电动工具之前，必须从电源上拔掉插头和/或使电池盒与工具脱开。这种防护性措施将减少工具意外启动的危险。
- 4) 将闲置不用的电动工具贮存在儿童所及范围之外，并且不要让不熟悉电动工具或对这些说明不了解的人操作电动工具。电动工具在未经培训的用户手中是危险的。
- 5) 保养电动工具。检查运动件是否调整到位或卡住，检查零件破损情况和影响电动工具运行的其他状况。如有损坏，电动工具应在使用前修理好，许多事故由维护不良的电动工具引发。
- 6) 保持切削刀具锋利和清洁。保养良好的有锋利切削刃的刀具不易卡住而且容易控制。

- 7) 按照使用说明书，考虑作业条件和进行的作业来使用电动工具，附件和工具的刀头等。将电动工具用于那些与用途不符的操作可能会导致危险。

#### 通用电动工具安全警告 - 电池式工具使用和注意事项

- 1) 只用制造商规定的充电器充电。将适用于某种电池盒的充电器用到其他电池盒时会发生着火危险。
- 2) 只有在配有专用电池盒的情况下才能使用电动工具。使用其他电池盒会发生损坏和着火危险。
- 3) 当电池盒不用时，将它远离其他金属物体，例如回形针，硬币，钥匙，钉子，螺钉或其他小金属物体，以防一端与另一端连接。电池端部短路会引起燃烧或火灾。
- 4) 在滥用条件下，液体会从电池中溅出，避免接触。如果意外碰到了，用水冲洗。如果液体碰到眼睛，还要寻求医疗帮助。从电池中溅出的液体会发生腐蚀或燃烧。

#### 通用电动工具安全警告 - 维修

- 1) 让专业维修人员使用相同的备件维修电动工具。这将保证所维修的电动工具的安全。

#### 专业要求

- 1) 对机器进行任何修护工作之前，都须先取出电池包
- 2) 禁止将机器置于雨或水中。
- 3) 请勿将电池包存储于高于 40°C 的环境下。
- 4) 在 0 至 30°C 的环境下充电，理想充电温度是 18 至 24°C。
- 5) 仅限配套使用本机随附的充电器和电池包。
- 6) 避免电池包连接短路。（比如：不要让螺栓、钉子等接触到电池包的正负极）
- 7) 禁止燃烧电池包或弃之于火中，会引起爆炸。
- 8) 禁止给已损坏的电池包充电。
- 9) 如果充电器上的电源线损坏，请及时更换。
- 10) 取下电池包之前务必先拨下充电器电源插头。
- 11) 充电过程中，充电器和电池包发热属正常现象。
- 12) 不使用机器时，请勿将充过电的电池包插在充电器上。
- 13) 充电结束，请立即将电池包拔离充电器。

- 14) 机器工作时，机身和电池包都会发热，属正常现象。
- 15) 禁止将废弃电池包置于火中或随生活垃圾处理，必须送回当地收集站或回收点回收
- 16) 在墙体、地板、天花板上拧螺钉或钻孔之前，要仔细检查是否布有电线电缆、天然气管道或者水管，以免被螺钉或钻头损坏。
- 17) 使用机器时需戴防护耳罩，否则可能导致听力受损。
- 18) 机器工作时，附件和金属部件会发热，属正常现象。
- 19) 操作机器时，机器可能会接触到隐藏的电线，必须握住机器的绝缘表面。接触到通电导线会使机器表面的金属带电，使用者受到电击。

#### 警告

电池包在温度过高或过度使用的情况下，可能会发生漏液现象。如果电池漏出的液体沾到皮肤上，要先用肥皂清洗，然后用柠檬汁、醋进行冲洗；若不慎触及眼睛，应立即用清水进行冲洗，并马上去医院检查治疗。

#### 电动扳手安全警告

1. 在紧固件可能触及暗线进行操作时要通过绝缘握持面来握持工具紧固件碰到带电导线会使工具外露的金属零件带电从而使操作者受到电击
2. 请佩带耳罩
3. 安装之前请仔细检查套筒上是否有磨损裂缝或损坏
4. 请牢握本工具
5. 请务必确保立足稳固在高处使用工具时确保下方无人
6. 适当的紧固扭矩可能会随着螺栓种类或尺寸需紧固工件材料等的不同而不同

#### 充电器安全警告：

1. 使用前请阅读说明书。
2. 仅在室内使用，禁止置于雨或水中。
3. 禁止给不可充电电池充电。
4. 如果电源软线损坏，为避免危险，必须由制造商、其维修部或类似部门的专业人员更换。

# 标记



为减少伤害，用户应仔细阅读说明书



禁止置于雨或水中



警告标记



禁止置于火中



请戴防护耳罩



请勿丢弃电池，将废旧电池送回到你当地收集或回收点回收



请戴防护眼镜



该产品包含有某些有毒有害物质，在环保使用期限内可以放心使用，超过环保使用期限之后则应该进入回收循环系统。



请戴防尘面具



仅在室内使用

## 产品中有毒有害物质或元素的名称及含量

部件名称	有毒有害物质或元素					
	铅 (Pb)	汞 (Hg)	镉 (Cd)	六价铬 (Cr(VI))	多溴联苯 (PBB)	多溴二苯醚 (PBDE)
外壳的金属部分	○	○	○	○	○	○
外壳的非金属部分	○	○	○	○	○	○
机械传动机构	×	○	○	○	○	○
电机组件	×	○	○	○	○	○
控制组件	×	○	○	○	○	○
附件	○	○	○	○	○	○
配件	○	○	○	○	○	○
连接件	×	○	○	○	○	○
电源线 * ①	○	○	○	○	○	○
电池系统 * ②	×	○	○	○	○	○

本表格依据 SJ/T11364 的规定编制。

○：表示该有害物质在该部件所有均质材料中的含量均在 GB/T 26572 规定的限量要求以下。

×：表示该有害物质至少在该部件的某一均质材料中的含量超出 GB/T 26572 规定的限量要求。

且目前业界没有成熟的替代方案，符合欧盟 RoHS 指令环保要求。

\* ①适用于采用电源线连接供电的产品。

\* ②适用于采用充电电池供电的产品。

产品环保使用期限内的使用条件参见产品说明书。

### 随机附件

机器型号	内容	数量
51073C	5.0 安时锂电 电池包	1
	4.0A 充电器	1

充满一个 5.0Ah 电池包约 80 分钟

充满一个 2.5Ah 电池包约 40 分钟

我们建议您从所购买电动工具的商店选配您的附件。请使用有知名品牌的高质量附件。请选择适合您工作所需的正确附件。请参考附件包装，您将获得附件使用的更多的方法及帮助。

### 机器规格

机器型号	51073C
夹头类型	1/2" 方头
电压	18 V
空载转速	0-1200 / 0-1800 / 0-2500 转 / 分钟
冲击频率	0-1600 / 0-2300 / 0-3200 次 / 分钟
最大转矩	220 牛顿·米
标准螺栓	M8-M16
高强度螺栓	M6-M14
机器重量	1.6 千克
电池容量	5000 毫安时
充电时间	80 分钟

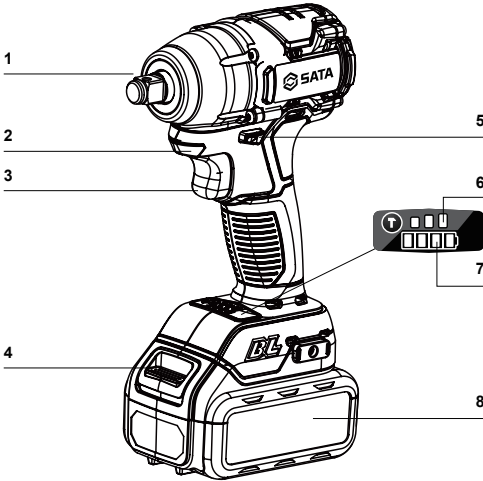

### 机件：

1. 方形传动头
2. 工作灯
3. 起停开关
4. 电池包锁钮
5. 换向拨杆
6. 速度档位选择（红灯）
7. 电量显示（绿灯）
8. 电池包

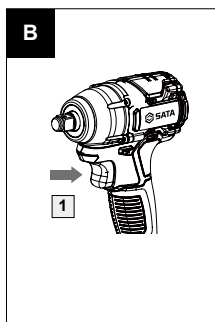
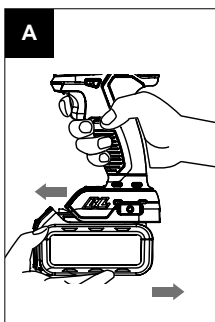

## 操作指南



注意：使用机器前，请仔细阅读说明书。

### 使用之前

#### 1) 充电

本充电器和机器需配套使用，严禁使用其他充电器。

本机器内设保护线路，当电池电量不足时，保护线路开启，机器停止转动。

在温度较高的环境中或者长时间使用后，机器可能会发烫，这时请不要立即充电，待电池冷却后再充电，否则将缩短电池的使用寿命或者因电池过热导致无法充电。

机器首次充电时或者长时间不用后，第一次充电器效率可能只能达到 60% 左右，需经 2-3 次的充放电之后，电池效率方可达到 100%。

#### 2) 安装 / 拆除电池包 (见图 A)

要取出电池包时，按下电池包前面的锁钮，然后将其拉出。要插入电池包时，只要将其轻推入机器即可。切忌用力过猛。

### 操作

#### 1. 启动 / 关闭 (见图 B)

按住开关 (1)，机器启动，松开则机器停止运转。

#### 2. 开关调速

在开关上的施力大小，可改变转速。改变范围在 0 至最大转速间，施力小，转速低，起钻稳固容易控制。在稳定可靠的启动后，充分按下开关以获得更快的速度。

#### 3. 速度档位选择 (见图 C)

使用时，先选择档位，再用开关控制转速；出厂时，机器是设定在最高档位，档位指示 (6) 有三个指示灯，3 个灯亮代表高档，2 个灯亮代表中档，1 个灯亮代表低档；如果想要改变档位选择，可按下 **T** 标记，每按一次更改一个档位

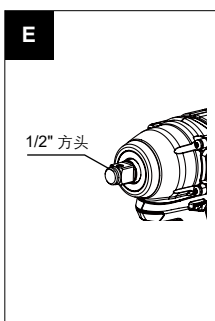
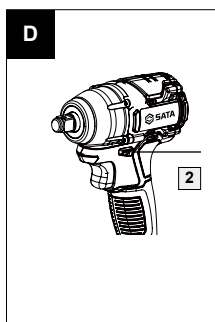
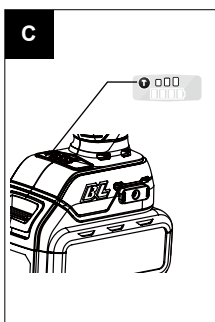

### 警告

请勿长时间轻轻按压开关低速操作，否则机器内部会产生过热反应。每次停机后再改变机器的转速档位。

#### 4. 开关锁定 (见图 D)

开关具有锁住保护功能，有利于减少在没有使用的情况下误启动手电钻。将转向拨杆 (2) 调节至正中位置，就可以将机器锁住。

#### 5. 改变旋转方向 (见图 D)

正转：把转向拨杆 (2) 标有 “◀” 一面推到底 (移至左侧)，可用于钻孔和旋入螺丝。反转：把转向拨杆拨标有 “▶” 的一面推到底 (移至右侧)，可用于转松或转出螺丝。

### ⚠ 警告

机器完全静止后才可变换转向。

#### 6. 安装或拆卸套筒 (见图 E)

注意：在安装或拆卸套筒时，一定先确认机器是否已关掉，电池包是否已取出。

##### 1) 无 O 型环和销的套筒

安装套筒：将其按压在工具的方形传动头 (1) 上，直至完全就位。

拆卸套筒：只需将其拔下即可。必要时可轻轻拍打。

##### 2) 带 O 型环和销的套筒

安装套筒：将 O 型环移出套筒凹槽，取下套筒上的销，将套筒置于方形传动头 (1) 上，使套筒上的孔与方形传动头的孔对齐，将销穿过套筒和方形传动头 (1) 上的孔，然后将 O 型环移回到套筒凹槽内的原始位置使销固定。

拆卸套筒：请按安装的相反步骤进行。

### ⚠ 警告





开机前，注意确保起子头被夹头完全固定。

#### 7. 工作灯

机器带有照明工作灯：当使用机器按下开关时，照明灯亮；松开，照明灯延迟 15 秒熄灭。

#### 8. 电池电量显示

按下机器开关，电量指示灯亮 5 秒，可按照下表判断电池包剩余电量。

LED 灯显示	剩余电量
	0-25%
	25-50%
	50-75%
	75-100%

#### 9. 操作

插入电池组时请务必使其完全锁紧到位，否则它可能会意外从工具中脱落而造成自身或他人受伤。

牢牢握住工具并将套筒置于螺栓或螺母上方，开启机器并以适当的紧固时间开始紧固。

适当的紧固转矩可能会随着螺栓种类或尺寸、需紧固工件材料等的不同而不同。总体上，紧固时间越久，紧固转矩越大。

##### 注：

- 使工具平直对准螺栓或螺母
- 紧固转矩过大可能损坏螺栓螺母或套筒，开始工作前，请务必进行试运转以确定适用于螺栓或螺母的适当紧固时间
- 如果工具连续工作到电池组电量耗尽，则应暂停使用工具 15 分钟，再用已充电的电池组继续操作。

紧固转矩受下述多种因素影响。紧固后，请务必使用转矩扳手确认转矩。

- 1) 当电池组电量将要完全耗尽时，电压将会下降，紧固转矩也会减小。
- 2) 套筒
  - 使用尺寸不正确的套筒，将会造成紧固转矩减小
  - 已经破损的套筒 (六角端或矩形端磨损) 会减小紧固转矩
- 3) 螺栓
  - 即使转矩系数和螺栓等级相同，但因其直径不同，所需紧固转矩也不同
  - 即使螺栓的直径相同，但依其转矩系数等级及其长度不同，所需紧固转矩也不相同
- 4) 使用万向节或延伸杆会在某种程度上减少冲击套筒扳手的紧固力，可通过延长紧固时间进行弥补
- 5) 握持工具的方式或上螺栓部位的材料也会影响转矩
- 6) 低速操作本机也会减小紧固转矩



## 问题解答：

### 1、为什么按压开关而机器却不运转？

在开关上部有一个转向拨杆，处在锁住的位置。将其拨向需要转动方向的位置，再按下按钮，机器就会开始转动。

### 2、为什么在还未拧紧时，机器就停止运转？

机器带有低压保护，在电池包电量过低时，机器不能工作，请确认电池包电量。

本机带有温度保护，当长时间满负荷工作时，电池包会过热，温保系统会启动导致机器停止运转，请将机器冷却到常温后再继续使用。

### 3、为什么同一个电池包的工作时间会有长有短？

一个电池包如果放置时间过长而不使用的话，就会缩短其工作时间，这就是充电次数问题。在经过几次充电和使用之后，这种状况就会得到改善。在干重活时，电池包的电量也会消耗的很快。不要在 0℃ 以下或 35℃ 以上的环境里充电，这同样会影响到电池包的工作表现。

## 保养与维护

对机器作任何换修工作之前，请务必先拔出插头。

您的电动工具不需要再添加润滑油或进行其它保养。不要用水或化学清洗剂来清洗你的电动工具，用干布擦拭干净就可以了。工具需储藏在干燥的环境中，并保持马达通风口处的清洁。尽量不要在灰尘较大的环境中使用。

为了有利于与电池包寿命，请注意：

- 1) 电池包存放：将电池包充电 30%-50% 电量，存放在 26℃ 以下环境中。
- 2) 不超过 6 个月时间，将电池包充满电使用一次。

## 废弃电池包的处理



为保护自然环境，请妥善回收或处理电池包。该电池包含有锂电池。请向当地废物处理部门咨询有关回收和（/ 或）处理的信息。通过使用手电钻把电池包电量耗尽，卸下电池包，用结实的胶带包裹好极片端口，避免短路和漏电。请勿试图打开或拆取任何部件。

## 环境保护



### 处理废弃物

为了响应环保，对于坏损的机器、配件及包装材料必须详细加以分类处理，以便于回收。

为方便分类回收，各塑胶部位都做有材料标识。

## GENERAL SAFETY WARNING OF ELECTRIC TOOL:

### WARNING

Read all warnings and instructions. Failure to follow the warnings listed below and instruction may result in electric shock, fire and/or serious injury. Keep all warnings and instruction for review. "Electric tool" in all of the following warnings refers to the electric tool driven by mains supply (wired) or the battery (wireless).

### General safety warning of electric tool - workplace

- 1) Keep the work area clean and bright. Disordered and dark site may cause accidents.
- 2) Do not operate the electric tool in the explosive environment such as the flammable liquid, gas or dust. The spark generated by the electric tool will ignite the dust or gas.
- 3) Operate the electric tool in the event of no children and bystanders around it. Inattention may cause the operator to lose control of tool.

### General safety warning of electric tool - electrical safety

- 1) Plug of electric tool shall be supported by the socket. Never modify the plug in any way. Any change-over plug shall not be used for the electric tool to be grounded. Unmodified plug and corresponding socket will reduce the risk of electric shock.
- 2) Do not contact the grounded surface such as the pipe, cooling fin and refrigerator. If your body is grounded, the risk of electric shock will increase.
- 3) Do not expose the electric tool to the rain or moisture. Water entering the electric tool will increase the risk of electric shock.

- 4) Do not abuse the wire. Never carry, pull the electric tool with wire or pull out its plug. Keep the electric tool away from heat source, oil, sharp edges or moving parts. Damaged or entangled cords may increase the risk of electric shock.
- 5) For the outdoor application, an external cord for outdoor use shall be used. A cord suitable for outdoor will reduce the risk of electric shock.
- 6) If it is inevitable to operate the electric tool in the humid conditions, the residual current device (RCD) shall be used. RCD is able to reduce the risk of electric shock.

### General safety warning of electric tool - personal safety

- 1) Keep alert and awake when operating the electric tool. Do not operate the electric tool when you are tired or have medication, alcohol or a therapeutic response. Instantaneous negligence in the operation of electric tool may result in serious personal injury.
- 2) Wear the personal protective equipment. Always wear the goggles. Safety devices, such as the dust mask, anti-slip safety shoes, helmet, listening protection, etc., are able to reduce the personal injury.
- 3) Prevent the accidental starting. Make sure that the tool is switched off when connecting the power supply and/or battery box, picking up or carrying the tool. Putting the finger on the switch which is powered on or inserting the plug when the switch is turned on may result in the danger.
- 4) Remove all adjustment keys or wrenches before turning on the electric tool. A wrench or key left on the rotating part of electric tool may cause the personal injury.

- 5) Do not stretch your hands excessively, and always pay attention to the foothold and body balance. This provides excellent control of electric tool in unexpected situations.
- 6) Dress properly. Do not wear loose clothing or jewelry. Keep the clothes, gloves and hair away from moving parts. Loose clothes, accessories or long hair may get caught in moving parts.
- 7) If a device for connecting the chip conveyor and dust collector is provided, make sure that they are connected well and used properly. These devices are able to reduce the risk of dust.

### **General safety warning of electric tool - use and precautions of electric tool**

- 1) Do not abuse the electric tool and select the appropriate electric tool according to the application. The appropriately designed electric tool will make your work more efficient and safer.
- 2) The electric tool shall not be used if the switch is unable to turn on/off the power. Electric tools that cannot be controlled with switches are dangerous and shall be repaired.
- 3) Before making any adjustments, replacing the accessories or storing the electric tool, remove the plug from the power supply and/or disengage the battery box from the tool. This protective measure will reduce the risk of accidental start of tool.
- 4) Place the unused electric tool outside the reach of children, and do not let the electric tool operated by the people who are not familiar with the electric tool or who do not understand these instructions. The electric tool is a potential threat in the hands of untrained users.

- 5) Maintenance of electric tool Check whether the moving parts are in place or stuck, check the parts for damage and other conditions that affect the operation of electric tool. The damaged electric tool shall be repaired before use. Many accidents are caused by poorly maintained electric tools.
- 6) Keep the cutting tool sharp and clean. Well-maintained tools with sharp cutting edges are not easy to get stuck and easy to control.
- 7) Use the electric tool, accessories, cutter bit, etc. in accordance with the instructions, taking into account the operating conditions and works to be performed. Applying the electric tool for operations that do not match the purpose may be dangerous.

### **General safety warning of electric tool - use and precautions of battery tool**

- 1) Charge the battery only with the charger specified by the manufacturer. Unmatched charger and battery pack may cause the risk of fire.
- 2) Use the electric tool only if a dedicated battery box is provided. Unmatched battery pack may cause the risk of damage and fire.
- 3) When the battery box is not in use, keep it away from other metal objects, such as the clip, coin, key, nail, screw or others, to prevent one end from being connected to the other end. A short circuit at the end of battery may cause a fire.
- 4) The abuse will make the liquid splash out of the battery. Therefore, the exposure shall be avoided. In case of accidental exposure, rinse it with water. In case of splash into the eye, seek the medical assistance. Liquid spilled from the battery

may cause the corrosion or burning.

## General safety warning of electric tool - repair

- 1) Have the qualified maintenance personnel to repair the electric tool with the same spare parts. This will ensure the safety of the electric tool being repaired.

## Professional requirements

- 1) Be sure to take out the battery pack before repairing the machine.
- 2) Do not place the machine in the rain or water
- 3) Do not store the battery pack above 40 °C.
- 4) Charge the battery from 0 to 30 °C, preferably 18 to 24 °C.
- 5) Only use the accompanied charger and battery pack.
- 6) Avoid the short circuit of battery pack. (For example: do not make the bolts and nails touch the positive and negative poles of battery pack)
- 7) Do not burn the battery pack or discard it in the fire. Otherwise, an explosion may occur. 8) Do not charge the damaged battery pack.
- 9) Replace the damaged power cord timely.
- 10) Be sure to pull the plug off before removing the battery pack.
- 11) During the charging, it is normal for the charger and battery pack to heat up.
- 12) When the machine is not in use, do not insert the charged battery pack into the charger.
- 13) After the charging is over, please pull the battery pack off the charger immediately.
- 14) During the operation, it is normal for the body and battery pack to heat up.

- 15) Do not put the discarded battery pack in fire or dispose it with domestic garbage, and be sure to send it to the local collection station or recycling point.
- 16) Carefully check for the cable, natural gas or water pipes before driving the screw or drilling the hole in the wall, floor and ceiling.
- 17) Wear the earmuffs when operating the machine. Otherwise the hearing may be damaged.
- 18) During the operation, it is normal for the accessories and metal parts to heat up.
- 19) The operating machine may come into contact with the hidden wires. Therefore, be sure to hold the insulating surface of machine. Contact with the live wires may electrify the metal on the surface of machine and cause an electric shock of user.

### WARNING

Battery pack leakage may occur if the operating temperature is too high or the pack is excessively used. If the liquid leaking from the battery gets on the skin, wash it with soap first, then rinse it with lemon juice or vinegar. In case of contact with the eyes, rinse the eyes with clean water immediately and go to the hospital for treatment.

## Safety warning of electric wrench

1. If the fastener may touch the concealed line, hold the tool at the insulating surface. The fastener touching the live wire may cause the exposed metal parts of tool to be electrified to shock the operator.
2. Please wear the earmuffs
3. Please check the sleeve for any wear, crack or damage before installation.
4. Please hold this tool firmly

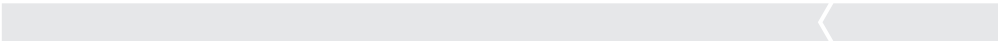
- 
5. Be sure to stand firmly and make sure that no one is underneath when using the tool at height
  6. The tightening torque may vary depending on the type or size of bolt and the material of workpiece to be fastened.

**Safety warning of charger:**

1. Please read the instruction before use.
2. Only for indoors, no rain or water
3. Do not charge the non-rechargeable battery.
4. The damaged power cord shall be replaced by the manufacturer, its service department or similar professional technicians, to avoid dangers.

## MARK



To reduce the damage, the user shall read the warning marks in instructions carefully



Warning marks



Please wear the earmuffs



Please wear the protective glasses



Please wear the dust mask



Only for indoors



Do not place the machine in the rain or water



Do not place it in the fire



Do not discard the battery and return the used battery to the local collection or recycling point.



It may be recycled and shall not be discarded at will. The battery pack contains certain toxic and harmful substances, and may be used safely during the environment-friendly use period. After the above period is expired, it shall be put into the recycling system.

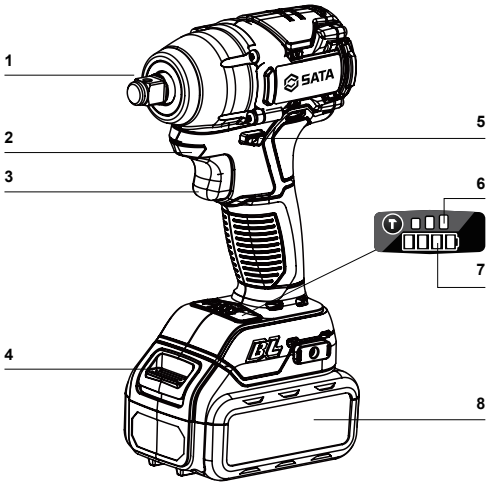

### Machine part:

1. Square driving head
2. Work light
3. Start/stop switch
4. Battery pack lock button
5. Reversing yoke
6. Speed position selection (red light)
7. Battery level display (green light)
8. Battery pack

### Accompanied accessories:

Model	Content	Quantity
51073C	5.0 Ah Li-ion battery pack	1
	4.0A charger	1

Charging duration of 5.0Ah battery pack: about 80min

Charging duration of 2.5Ah battery pack: about 40min

We recommend that you choose the accessories from the store where you purchased the electric tool. 7 Please use the high-quality accessories from the well-known brands. Please choose the right accessory for your job. Please refer to the accessory package and you will get more methods and help for using the accessory.

### Specification

Model	51073C
Chuck type	1/2" square head
Voltage	18V
No-loading speed	0-1200/0-1800/0-2500 rev/min
Frequency	0-1600/0-2300/0-3200 impacts/min
Max. torque	220 N·m
Standard bolt	M8-M16
High-strength bolt	M6-M14
Machine weight	1.6kg
Battery capacity	5000mAh
Recharge time	80min

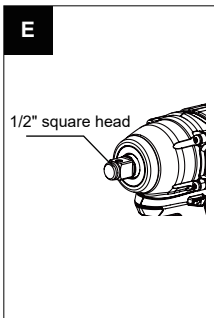
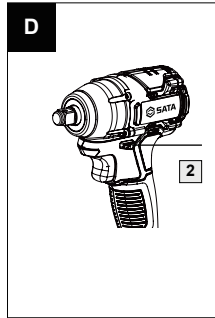
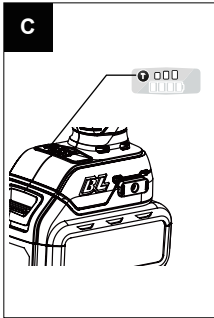
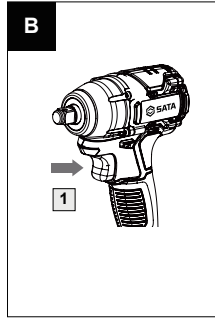
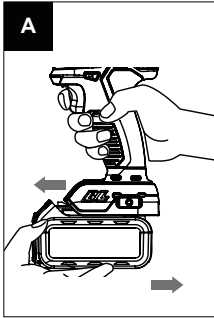

## Operation guideline



**Caution:** Please read the instruction carefully before operating the machine.

## Before the use

### 1) Charging

This charger and machine shall be used together. Do not use other chargers. The machine has a protection circuit. When the battery is low, the protection circuit is turned on and the machine stops rotating.

The machine may become hot under the high temperatures or after a long period of operation. At this time, do not charge immediately but wait until the battery is cooled. Otherwise, the service life of battery will be shortened or the charging failure may be caused due to overheating.

For the first charging or after a long period of storage, the efficiency of first charging may only reach about 60%. After 2-3 charging and discharging cycles, the battery efficiency may reach 100%.

### 2) Installation and removal of battery pack (see Figure A)

Press the lock button on the front of battery pack and pull it out. To insert the battery pack, simply push it into the machine while avoiding the excessive force.

## OPERATION

### 1. Start/stop (see Figure B)

Press and hold the switch (1) to start the machine, and release it to stop the machine.

### 2. Speed regulation

Change the force applied to the switch to regulate the rotating speed. The range of adjustment is between 0 and the maximum



rotating speed. The smaller the force is, the lower the rotating speed is. The drilling starts slowly and stably. After the stable and reliable start, press the switch fully for higher speed.

### 3. Speed position selection (see Figure C)

First select the position, and then regulate the rotating speed with switch; the highest position is selected at delivery and there are three red position indicators (6) where three ones going on means the high position, two ones going on means the mid position and one going on means low position: Change the position once each time you press the  "icon".



#### **WARNING**

Do not operate at low speed for a long time by pressing the switch. Otherwise the machine will be overheating inside. Change the rotating speed after stop.

### 4. Switch lock (see Figure D)

The switch has the lock protection function which helps to avoid the accidental activation of the hand drill. Lock the machine by adjusting the reversing yoke (2) to the center position.

### 5. Rotation reversing (see Figure D)

Forward: Push the side of reversing yoke (2) marked with "" to the end (left side) for drilling and driving the screw. Reverse: Push the side of reversing yoke marked with "" to the end (right side) for releasing or unscrewing the screw the screw.

#### **WARNING**

The rotating speed can only be changed after the machine is completely still.

### 6. Installation or removal of sleeve (see Figure E)

**Caution:** When installing or removing the sleeve, be sure to confirm that the drill has been turned

off and that the battery pack has been removed.

#### 1) Sleeve without O-ring and pin

Install the sleeve: press it on the square driving head (1) of tool until it is fully seated

Remove the sleeve: just unplug it.

Gently tap it if necessary

#### 2) Sleeve with O-ring and pin

Install the sleeve: Move the O-ring out of the sleeve groove, remove the pin on the sleeve, place the sleeve on the square driving head (1), align the hole in the sleeve with that on the square driving head, and fit the pin through the holes in the sleeve and square driving head (1), and then return the O-ring to the original position in the sleeve to fix the pin.

Remove the sleeve: please follow the reverse steps of installation

#### **WARNING**





Before starting the machine, make sure that the screwdriver bit is fully fixed by the chuck.

## 7. WORK LIGHT

Machine is equipped with the work light: when the switch is pressed, the light will come on; when it is released, the light will go out 15s later.

## 8. BATTERY LEVEL DISPLAY

When the machine switch is pressed, the battery indicator will stay on for 5s. The remaining capacity of battery pack may be determined according to the following table.

LED display	Remaining battery
	0-25%
	25-50%
	50-75%
	75-100%

## 9. Operation

Be sure to fully lock the battery pack as it may accidentally fall out of the tool and cause injury to yourself or others. Hold the tool firmly and place the sleeve above the bolt or nut, turn the machine on and tighten it properly.

The tightening torque may vary depending on the type or size of bolt and the material of workpiece to be fastened. Generally, the longer the tightening time is, the larger the tightening torque is.

### Note:

Align the tool straightly with the bolt or nut.

Excessive tightening torque may damage the bolt nut or sleeve. Before the operation, be sure to conduct the test run to determine the proper tightening time for the bolt or nut.

If the tool keeps operating until the battery pack is exhausted, the operation shall stop for 15min, and then continue the operation with the charged battery pack. Tightening torque depends on the various factors described below. After tightening, be sure to confirm the torque with the torque wrench.

1) When the battery pack is about to run out completely, the voltage will drop and the tightening torque will also decrease.

2) Sleeve

Incorrectly sized sleeve will result in the decrease of tightening torque

Damaged sleeve (wear of hex end or rectangular end) will reduce the tightening torque

3) Bolt

Even if the torque coefficient and the bolt level are the same, the tightening torque is different because of the different diameters.

Even if the diameter of bolt is the same,

the required tightening torque is different depending on its torque coefficient and its length.

4) Universal joint or extension rod will reduce the tightening force of the impact sleeve wrench to some extent, which can be compensated by the extension of tightening time.

5) The way the tool is held or the material on the bolt will also affect the torque.

6) Operating at low speed will also reduce the tightening torque.

## QUESTION AND ANSWER:

### 1. Why does the machine not operate after the switch is pressed?

The reversing yoke on the upper part of switch is locked. Turn it to the position where the rotation is in need, and then press the button to rotate the machine.

### 2. Why does the machine stop when it is not tightened?

The machine has low-voltage protection. When the level of battery pack is too low, the machine will not work. Please confirm the level of battery pack.

The machine has temperature protection. When the battery is working at full load for a long time, the battery pack will overheat and the temperature protection system will start to stop the machine. Cool the machine to normal temperature before resumption.

### 3. Why is the service life of same kind of battery pack is different?

If a battery pack is left unused for a long time, its service life may be shortened. This is the matter of charging frequency. Repeated charging and application may improve the

situation. In case of heavy work, the battery pack will run out soon. Do not charge in a temperature below 0 °C or above 35 °C. Otherwise, the performance of battery pack will be affected.

## MAINTENANCE

**Be sure to pull off the plug before repairing or replacing the machine.** The electric tool does not require additional lubrication or other maintenance. Do not wash the electric tool with the water or chemical cleaner. Wipe it off with a dry cloth. Tool shall be stored under the dry conditions and kept clean at the vent of motor. Try not to use it in a dusty environment.

### To prolong the service life of battery pack:

- 1) Store the battery pack below 26 °C after charging it to 30%-50%.
- 2) Charge the battery pack fully once in less than 6 months.

## DISPOSAL OF DISCARDED BATTERY



To protect the natural environment, please recycle or dispose of the battery pack properly. The battery pack contains a Li-ion battery. Please consult the local waste disposal department for the information on recycling and/or disposal. Exhaust the battery pack with the hand drill, remove the battery pack, and wrap the pole port with strong tape to avoid the short circuit and leakage. Do not attempt to open or remove any part.

## PACK

### Disposal of waste



The damaged machine, accessories and packaging materials shall be classified in detail for recycling in line with environmental protection requirements.

All plastic parts are marked with material identifications to facilitate the classification and recycling.

型号/Model

51073C

版本号/Version No

V\_SC\_51073C\_202104

世达工具（上海）有限公司

SATA TOOL (SHANGHAI) LIMITED

客户服务：上海市浦东新区碧波路 177 号 A 座 302 室

Customer service: Room 302, Area A, No. 177, Bibo Road, Pudong New Area, Shanghai

邮编 /Post: 201203

电话 /Tel.: [86 21] 6061 1919

传真 /Fax: [86 21] 6061 1918